

# Data Sheet



Article number: 0121053

Description: Retaining ring JL 36X1,5  
Spring steel

## Measures

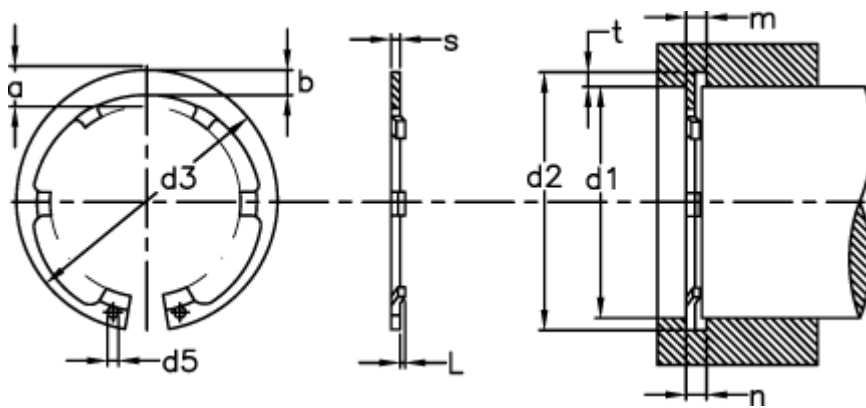

a max	= 5.6	FL max kN	= 0.87	s	= 1.50
b	= 3.6	FN kN	= 19.4	tol	= 0.25
C kN/mm	= 2.48	FRg kN	= 6.40	tol	= +0,50 -0,25
d1	= 36	FR kN	= 26.40	u	= 0.10
d2	= 38.0	g	= 1.5		
d3	= 38.8	L min	= 0.45		
d5 min	= 2.5	m min	= 1.60		
Description	= AL 36	Nominal drive	= 3.0		